

Acme Insulated Service Doors

STANDARD REQUIRED CLEARANCES

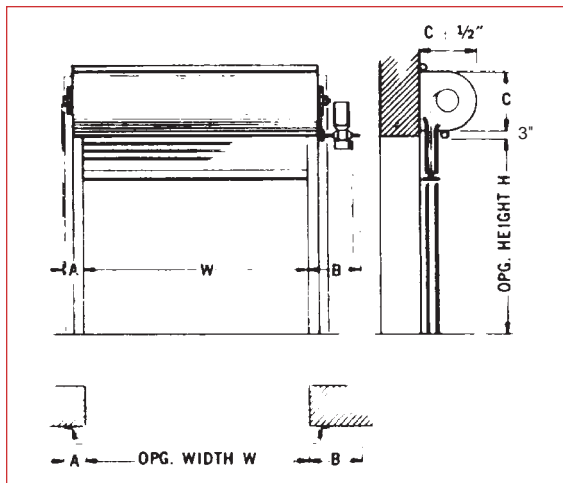

MOTOR FACE OF WALL

Width to	Height to	A	B	C
UP TO 8'-0"	UP TO 7'-6"	6-1/2"	8"	1'-3"
8'-0"-10'-0"	7'-6"-12'-0"	7"	9"	1'-5"
10'-0"-16'-0"	12'-0"-16'-0"	7-1/2"	10"	1'-7"
16'-0"-18'-0"	16'-0"-19'-0"	8-1/2"	11"	1'-9"
18'-0"-22'-0"	19'-0"-22'-0"	9"	12"	1'-10"
22'-0"-25'-0"	22'-0"-26'-0"	10"	1'-8"	2'-0"

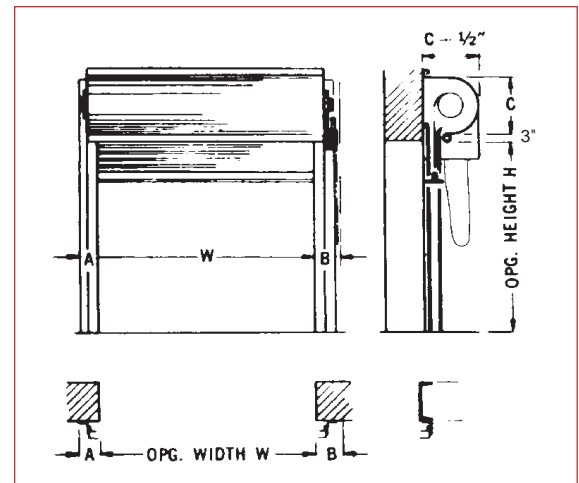

CHAIN FACE OF WALL

Width to	Height to	A	B	C
UP TO 8'-0"	UP TO 7'-6"	6-1/2"	7-1/2"	1'-3"
8'-0"-14'-0"	7'-6"-12'-0"	7"	8"	1'-5"
14'-0"-18'-0"	12'-0"-16'-0"	7-1/2"	10"	1'-7"
18'-0"-25'-0"	16'-0"-19'-0"	8-1/2"	11"	1'-9"

STANDARD SPECIFICATIONS

Add to Acme Door standard door specifications on page 4: Doors shall be "Energy Saver" model insulated rolling service doors as manufactured by Acme Rolling Steel Door Corporation-Ridgefield, NJ (800) 281-5680.

Curtains: Shall be constructed of interlocking cold roll formed galvanized steel slats front and back, 2 3/4" high x 3/4" thick enclosing Polyurethane foamed-in-place insulation with an over all U Factor of 0.187, R Value of 5.35 as calculated according to ASHRAE formula.

Weatherstripping: "Energy Saver" insulated doors include "Air Seal" weatherstrip package, Neoprene hood baffle attached to inside of hood, continuous extruded vinyl snap-on weatherstripping at guides and neoprene loop astragal to ensure tight contact with the sill and minimize air infiltration around entire perimeter of door.

Operation: Doors to be chain hoist operated using gear reduction and galvanized handchain as standard.

Available Options: "Energy Saver" insulated doors options include electric motor operators, safety edge on bottom bars, vision lites, optional primed exterior curtains, galvanized guides, continuous endlocks, windlocks, high cycle springs, slide bolt or cylinder locking on bottom bars, wicket doors and special windload requirements.

See page 4 for specifications or consult factory.

ACME "ENERGY SAVER" INSULATED DOORS

Energy Saver's foamed in place polyurethane insulation is the single most effective insulation available today. Pumped in under pressure, it expands and fills every space inside the slat, creating an exceptionally strong metal foam metal bond. The "Energy Saver" incorporates full perimeter weatherstripping, including a hood baffle along the entire length of the hood, vinyl weatherstripping on the guides and neoprene astragal seal on the bottom bar at the floor minimizing air flow.

Acme "Energy Saver" Insulated Doors are available in 22, 20 or 18 gauge galvanized steel exterior skin (optional select based on finish colors available) with 24 gauge galvanized steel interior skin standard (Printed backing available) Doors can be provided with chain hoist, winding crank or electric motor operators and can include options such as: vision lites, windlocks, lintel baffles, double guide weatherstripping, slide bolt locks, stripping bottom bars, rodent resistant bottom bars, and a wicket door within the rolling door among others.

Engineering calculations indicate an overall U Factor of 0.187, R Value of 5.35 as calculated according to ASHRAE formula. (Tested or actual values may vary from calculated values.)

ACME ROLLING STEEL DOOR CORPORATION (800) 281-5680
P.O. BOX 33, 1099 LINDEN AVENUE, RIDGEFIELD, N.J. 07075 - FAX: 201-940-1266

